

料号 Part NO.	品名 Parts Name	A	B
34-TP2.5-19	塑胶铜柱 TP2.5-19	19.0	5.0

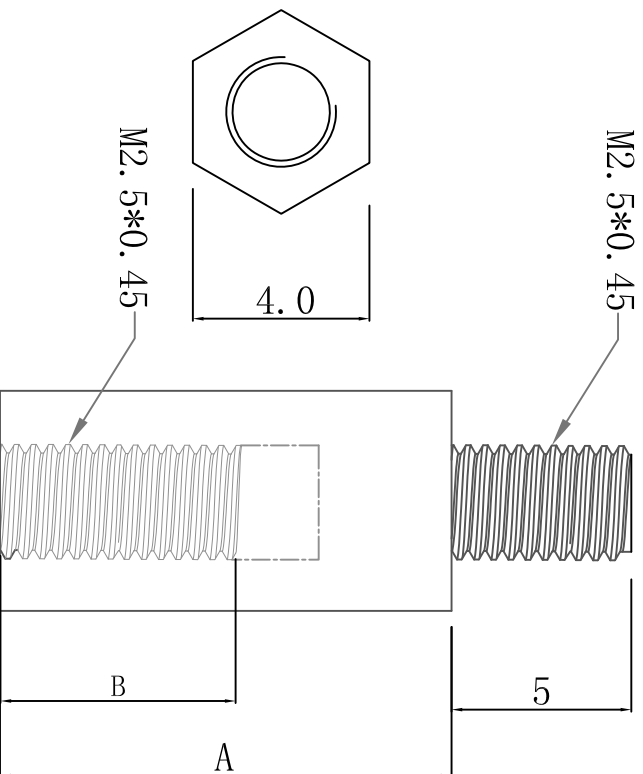

◆ MATERIAL: NYLON66 (UL) 94V-2
◆ UNIT: mm
用途: 做为PC板与机板间之固定, 六角型不滑动。



未经授权不得修改和复印
该知识产权属于技术质量部;

DIMENSION		TOLERANCES		FIRST ANGLE PROJ		LTR.	NEW PART	REVISION RECORD	DWG. BY	CHK. BY	DATE
0.0	0.00	±0.5				A			<i>oullian</i>	<i>zy wang</i>	<i>2011/28</i>
DWG. BY	<i>Lin Liang</i>	UNIT	mm	CHK. BY	<i>oullian</i>	REV.	A	APP. BY	<i>wang jiaqian</i>	DWG. NO.	HIMA/QR-JZ-34-TP2.5-19