

料号 Part NO.	品名 Parts Name	A (MM)
34-LEDK-6	间隔柱 LEDK-6	6.0

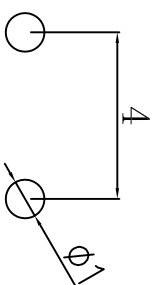

MATERIAL: NYLON 66 (UL)
 FLAME CLASS: 94V-2
 COLOR: NATURAL (白色)
 UNIT: mm
 用途: 用于保护LED立于PC板上, 使高度一致, 中间隔板设计, 接脚不会弯曲、折断、短路。
 公差要求: 未标注公差±0.3

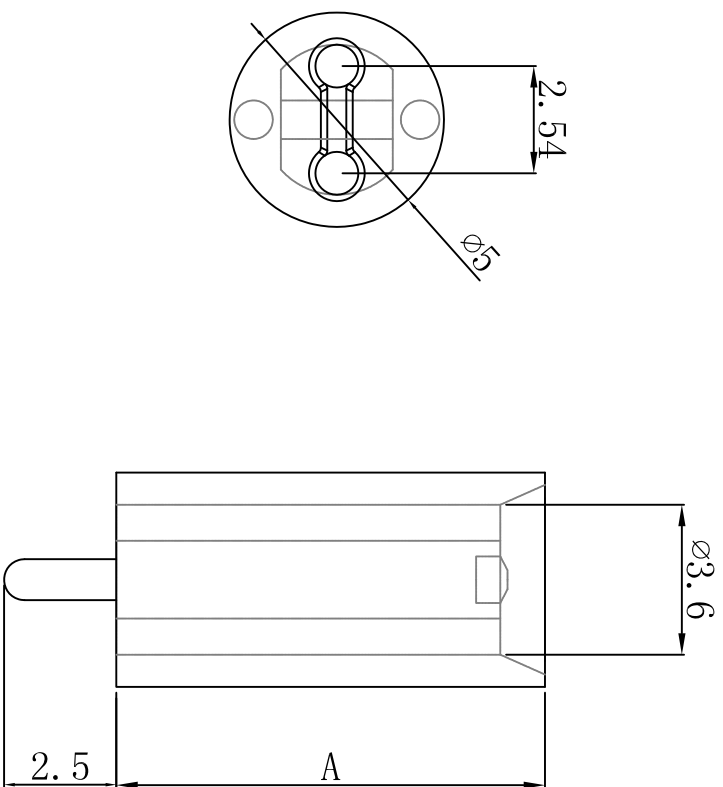

未经并受权不得修改和复印
 该知识产权属于技术质量部;

DIMENSION		TOLERANCES		FIRST ANGLE PROJ		LTR.		REVISION RECORD		DWG. BY		CHK. BY		DATE	
0.0	0.00	±0.3				A		NEW PART		oullian		yq wang		2011/28	
DWG. BY		CHK. BY		APP. BY		UNIT		REV.		DWG. NO.		mm		A	
Liu Liang		oullian		wang zhaoyan		A		1		HIWA/QR-JZ-34-LEDK-6					



苏州惠华电子科技有限公司