

料号 material No.	品名 Parts Name	型号 Part NO.	螺钉口直径 Screw dia. d2ø	Dimensions(mm)			导线截面 Cable size (mm ²)
40-SC400-16	窥口铜接线端子	SC400-16	17.0	dø	Dø	L1	L
			27.0	34.0	46.0	102.0	400

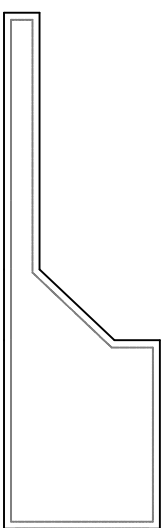

材质：紫铜
表面处理：镀锡

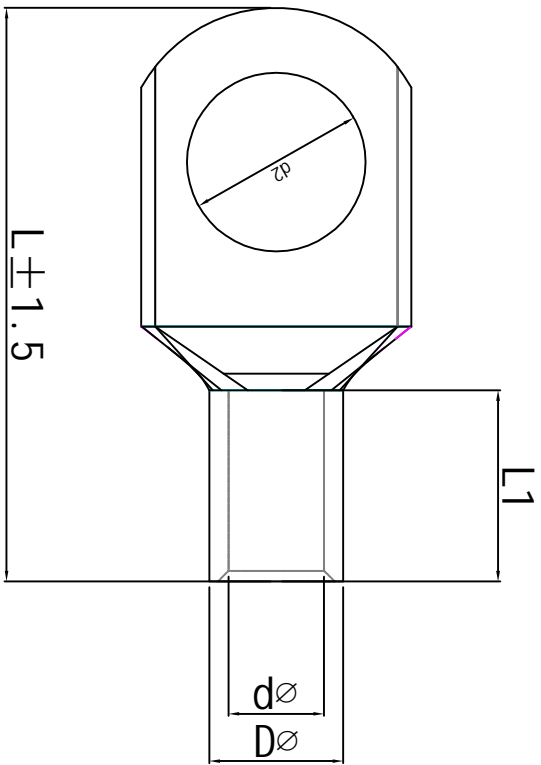

未经授权不得修改和复印
该知识产权属于技术质量部

DIMENSION		TOLERANCES		NEW PART		REVISION RECORD		DWG. BY	UNIT	mm
0.0								liu liang		
0.00		±0.5						sullivan	REV.	A
FIRST ANGLE PROJ		A		zy wang		2020/08		APP. BY	wang zhiyan	DWG. NO.
								苏州惠华电子科技有限公司		